

A8601 - Non-touch Hand Drier

Manufactured from 1.2mm thick grade 304, satin polished stainless steel. It has a capacitor start, brushless motor, centrifugal fan and fully-supported, spiral wound, heating element, rated at 2.4kW with automatic re-set overload protection and is automatically operated by an infra-red sensor and associated circuitry with automatic safety cut-out after 70 seconds continuous running. Supply should be 220/240V, 50Hz, single phase and the hand drier connected to the final subcircuit via a double-pole isolator switch, fused at 13A.

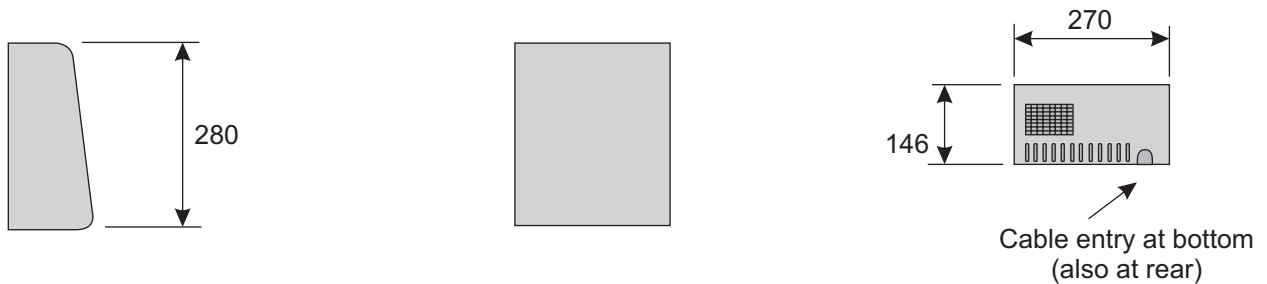

A8602 - Paper Towel Dispenser

Manufactured from 0.76mm thick grade 304, satin polished stainless steel with a lockable, bottom-hinged front, that swings open fully for easy servicing and dispenses 300 to 500, multi-fold or C-fold paper towels.

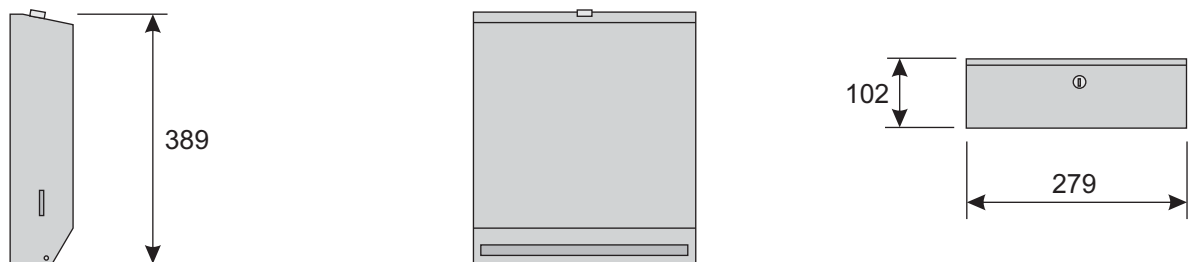

A8609 - Waste Bin

Manufactured from 0.76mm thick grade 304, satin polished stainless steel. **A8610** with hinged lid is also available.

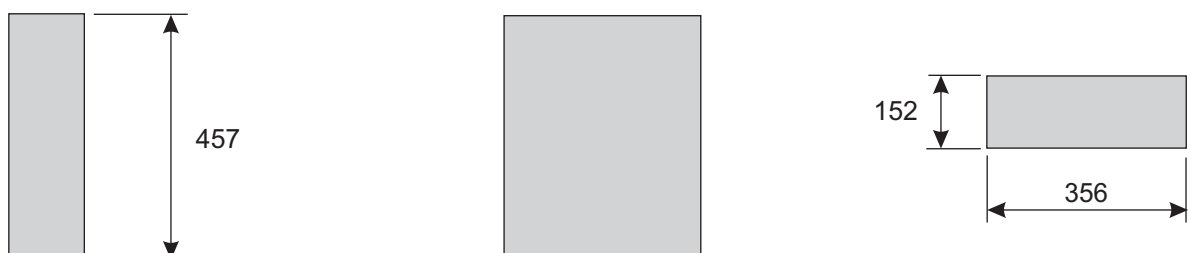

A8608 - Ashtray

Manufactured from 0.76mm thick grade 304, satin polished stainless steel. Ashtray flips over without removal.

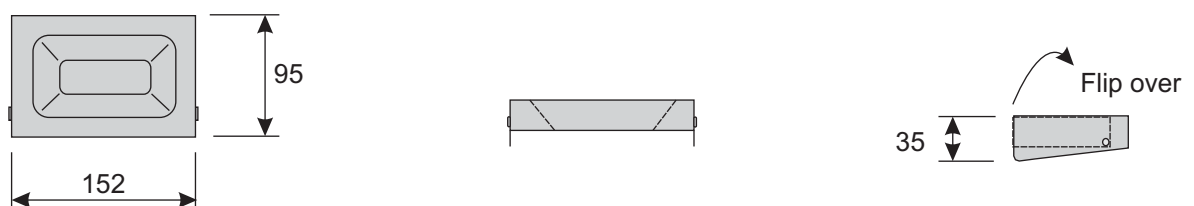

A8616 - Napkin Disposal Bin

Manufactured from 0.76mm thick grade 304, satin polished stainless steel with a hinged lid and lockable, hinged bottom for easy servicing (removal of liner).

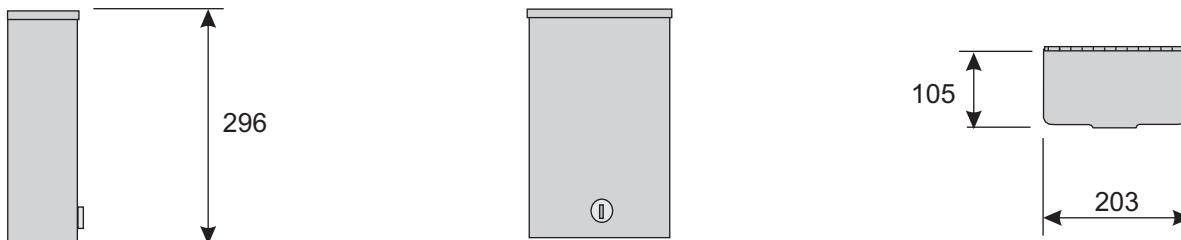

A8613 - Mini Jumbo Toilet Roll Holder

Manufactured from 0.76mm thick grade 304, satin polished stainless steel with a lockable, removable, front cover for easy servicing. A 220mm pack gives 300m single sheet or 210m double sheet.

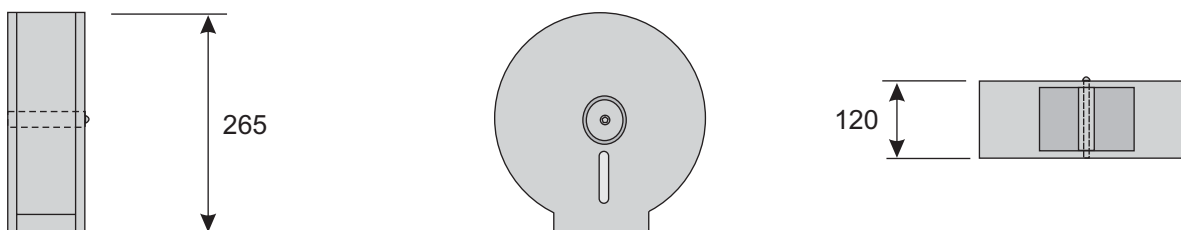

A8615 - Double Toilet Roll Holder

Manufactured from 0.76mm thick grade 304, satin polished stainless steel with a lockable, front cover for easy servicing. Holds two 114x114 standard core toilet rolls. **A8615R** recessed model is also available.

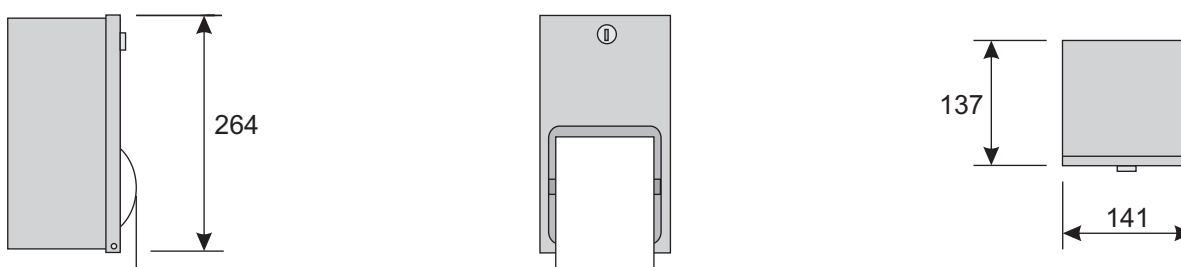

A8606 - Toilet Tissue Dispenser

Manufactured from 0.76mm thick grade 304, satin polished stainless steel with a lockable, bottom-hinged front, that swings open fully for easy servicing.

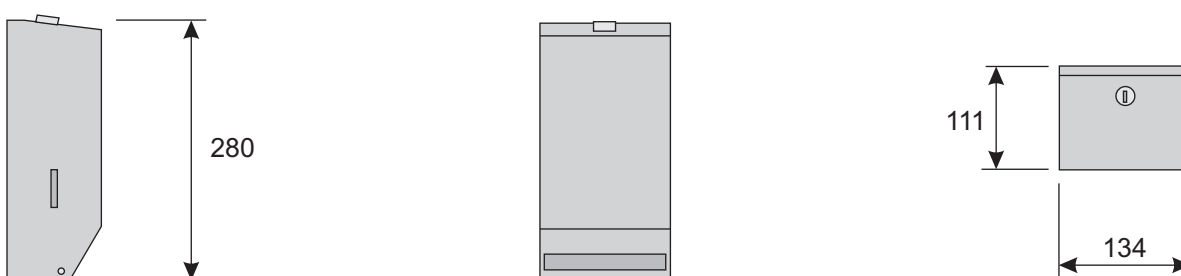

A8603 - Liquid Soap Dispenser

Manufactured from 0.91mm thick grade 304, satin polished stainless steel with a chromium-plated brass valve (with stainless steel moving parts), key-operated filler cap, lexan level indicator and 1.2 litre capacity. An **A8603V** vertical model is also available.

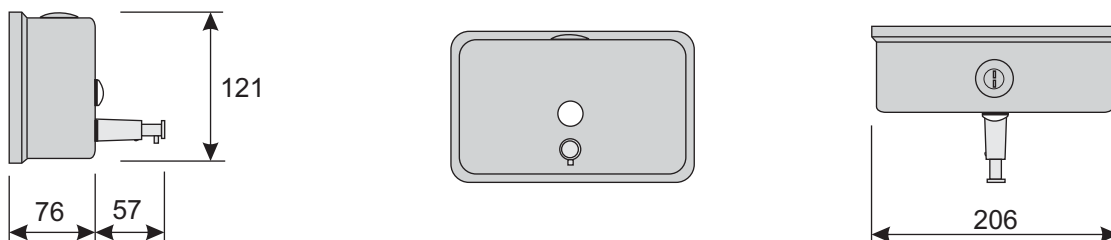

A8611 - Liquid Soap Dispenser

Manufactured from chromium-plated brass (with stainless steel moving parts), designed for top filling, with a 0.5 litre polyethylene container. A 25mm hole is required for installation through a maximum mounting thickness of 102mm.

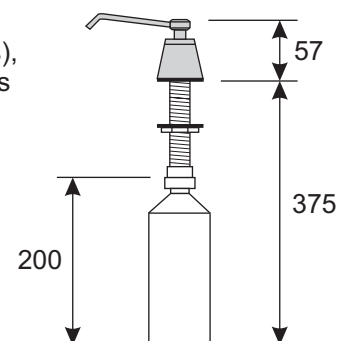
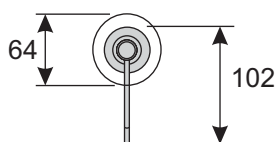

A8607 - Soap Shelf

Manufactured from 0.91mm thick grade 304, satin polished stainless steel with concealed fixings.

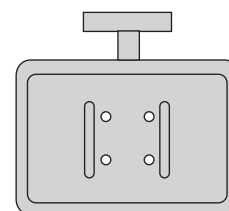
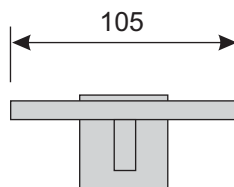
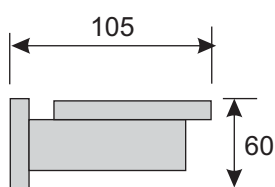

Robe Hooks

Manufactured from 0.91mm thick grade 304, satin polished stainless steel with concealed fixings..

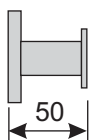

A8617
single

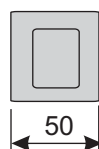

A8617D
double

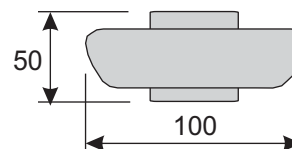

Stainless Steel Mirrors

Manufactured from 1.2mm thick grade 304, mirror polished stainless steel with four fixing holes. Please ensure the mirrors are fixed to a flat surface, or distortion will occur. Any size is available on request.